

2 Piece Ball Valve Stainless Steel

- The thread ends conform to NPT, BSPT, DIN259, Din 2999
- Investment Casting Body
- Blow-out proof stem / reduce port
- 1000PSI (69Bar) WOG
- PTFE / RTFE seat
- Locking Device

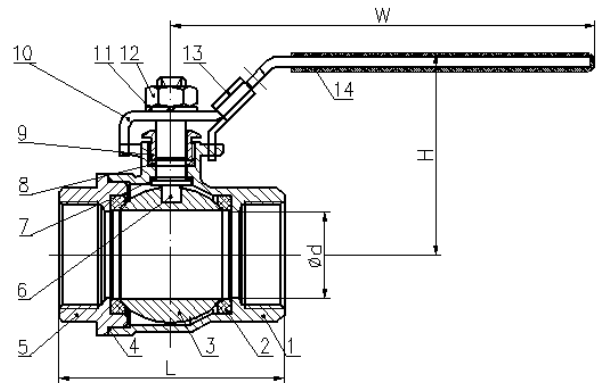

Material List		
Item	Part	Material
1	Lever	Stainless Steel
2	Lever Bolt	Stainless Steel - Grd304
3	Hex Nut	Stainless Steel
4	Std Spring Gasket	Stainless Steel
5	Gland Packing	A2-70
6	Thrust Packing	PTFE
7	Spindle	Stainless Steel - Grd304
8	Ball	A276-316
9	Back Seat	PTFE
10	Cap	Stainless Steel - Grd304
11	Body	A351-CF8M
12	Bottom Seat	PTFE



Dimensions						
Size		d	L	E	H	Mass (kg)
mm	Inch					
8	1/4"	5	40	67	33	0.06
10	3/8"	7	45	67	36	0.1
15	1/2"	9	58	93	37	0.16
20	3/4"	12.5	60	93	42	0.26
25	1"	16	71	103	52	0.38
32	1 1/4"	20	78	103	56	0.61
40	1 1/2"	25	82.5	125	65	0.85
50	2"	32	100	125	70	1.4